

構成内容 / Components				
No.	名称 / Part name	数量 / Pcs	材質 / Material	色・表面処理 / Color・Finish
1	上下カバー Top and Bottom cover	各1 1 each	アルミ板 A1100P t2.0 Aluminium A1100P t2.0	シルバーアルマイト Silver・Anodized
2	Wパネル W panel	2	アルミ板 A1100P t2.0 Aluminium A1100P t2.0	シルバーアルマイト Silver・Anodized
3	Dパネル D panel	2	アルミ板 A1100P t2.0 Aluminium A1100P t2.0	シルバーアルマイト Silver・Anodized
4	支柱 Extruded pillar	4	アルミ押出材 A6063S-T5 Extruded aluminium A6063S-T5	シルバーアルマイト Silver・Anodized
5	取付ビス (六角穴付皿M4 x 10) Screw (Hexagonal M4 - 10)	8	ステンレス Stainless steel	無処理 Unfinished
6	ゴム足 / Rubber feet	0 or 5	ポリウレタン / Polyurethane	透明 / Transparent

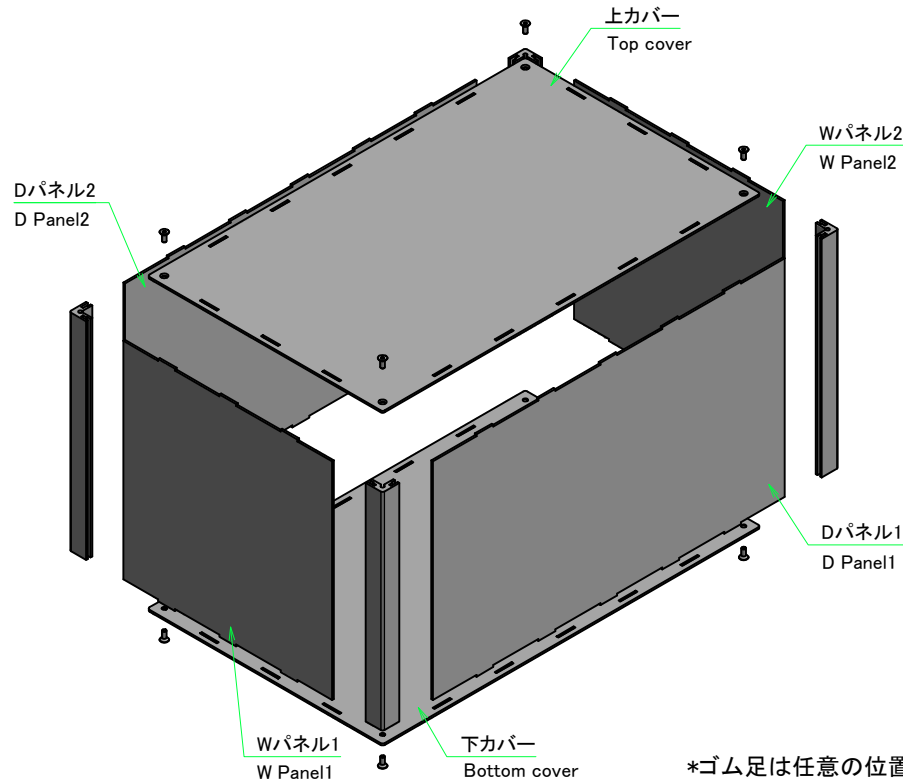

■六角レンチ付です。
Hexagonal wrench included.

ケース型番 / Product Number

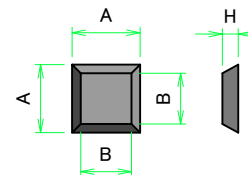
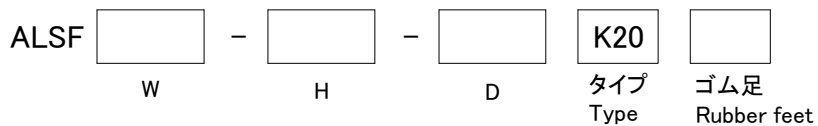

*ゴム足は任意の位置に貼り付けできます。
*Adhesive rubber feet in cluded

ゴム足 / Rubber feet			
記号 / Code	A	B	H
N (無し) / None	-	-	-
S	12.7	9.5	3
L	20.6	12.7	7.6

W・H・D 寸法制限範囲 / Dimension limit range		
W	H	D
201 ~ 250	30 ~ 500	151 ~ 200

株式会社タカチ電機工業 TAKACHI ELECTRONICS ENCLOSURE CO., LTD.			品名/Title 角型アルミフリーサイズケース CUSTOM SIZED ALUMINIUM CASE	尺度/Scale 1 / 5
承認/Approved 中根	検閲/Checked 常山	製図/Created 野村	型番/Product number ALSF□-□-□K20□ (W201~250, D151~200) 作成日/Date 2021/01/08	

外視 / External View

Wパネル2 / W Panel 2

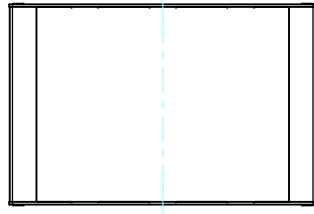

Dパネル2 / D Panel 2

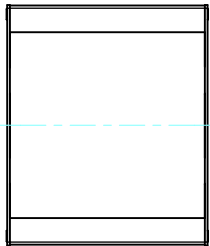

上カバー / Top cover

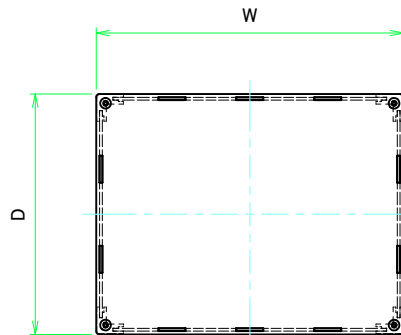

Dパネル1 / D Panel 1

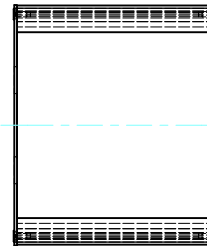

下カバー / Bottom cover

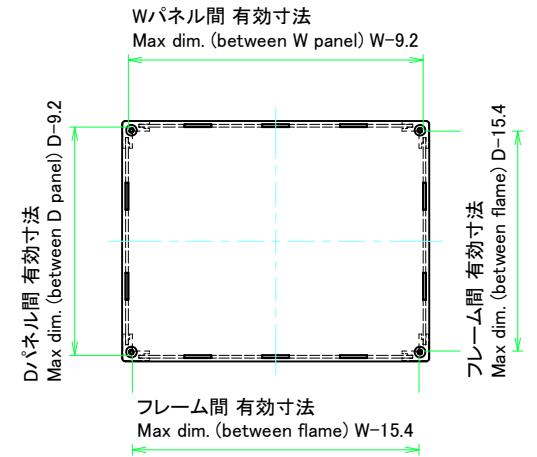

Wパネル1 / W Panel 1

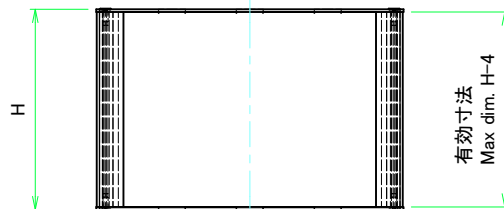

株式会社タカチ電機工業 <small>TAKACHI ELECTRONICS ENCLOSURE CO., LTD.</small>			品名/Title 角型アルミフリーサイズケース CUSTOM SIZED ALUMINIUM CASE	尺度/Scale 1:4
承認/Approved 中根	検図/Checked 常山	製図/Created 野村	型番/Product number ALSF□-□-□K20□ (W201~250, D151~200)	
			作成日/Date 2021/01/08	2 / 5

上下カバー / Top and Bottom cover

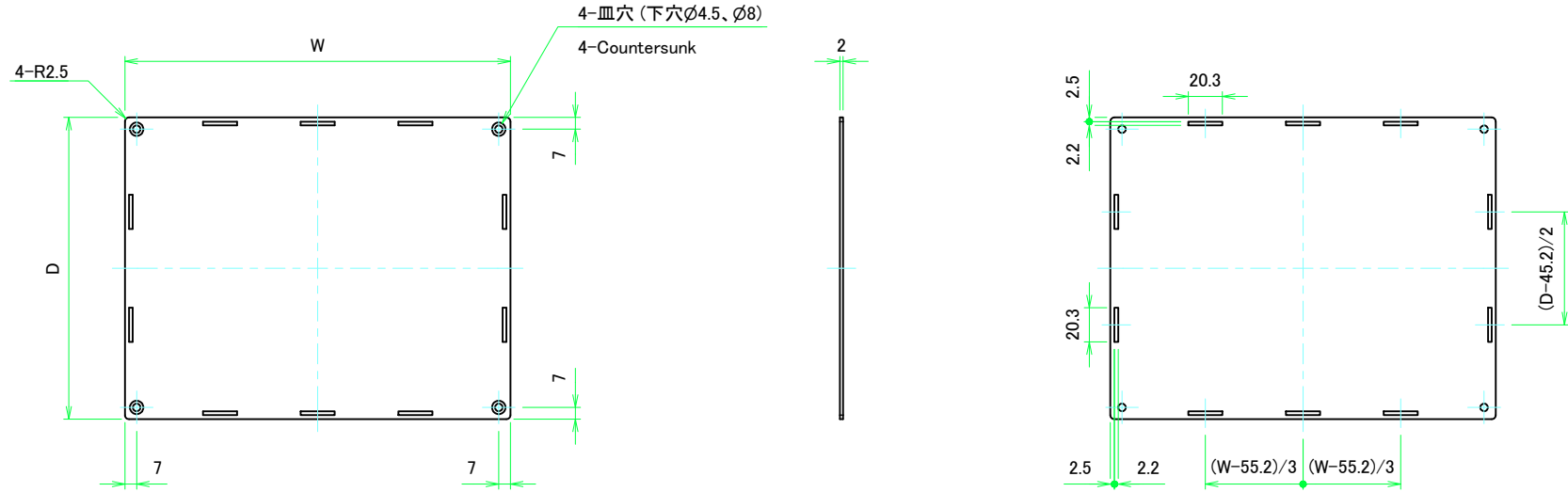

上カバー表面 / Top cover Frontside

上カバー裏面 / Top cover Backside

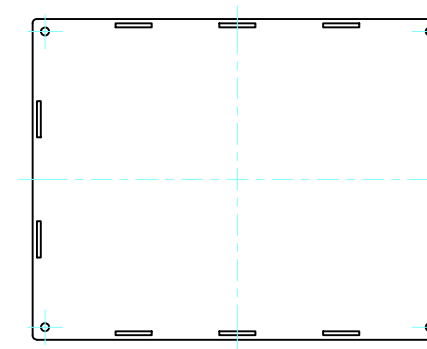
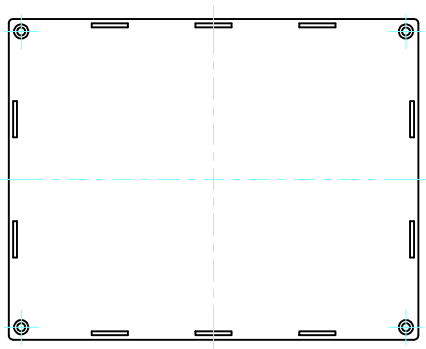

下カバー表面 / Bottom cover Frontside

下カバー裏面 / Bottom cover Backside

株式会社タカチ電機工業 <small>TAKACHI ELECTRONICS ENCLOSURE CO., LTD.</small>			品名/Title 角型アルミフリーサイズケース CUSTOM SIZED ALUMINIUM CASE	尺度/Scale 1:3
承認/Approved 中根	検図/Checked 常山	製図/Created 野村	型番/Product number ALSF□-□-□K20□ (W201~250, D151~200)	
			作成日/Date 2021/01/08	3 / 5

Wパネル / W Panel

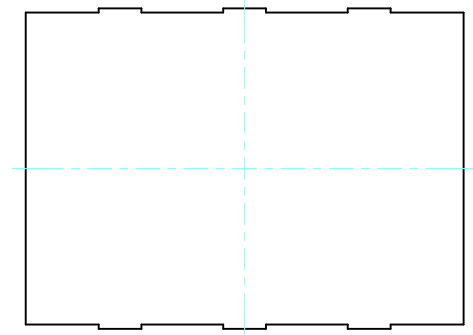
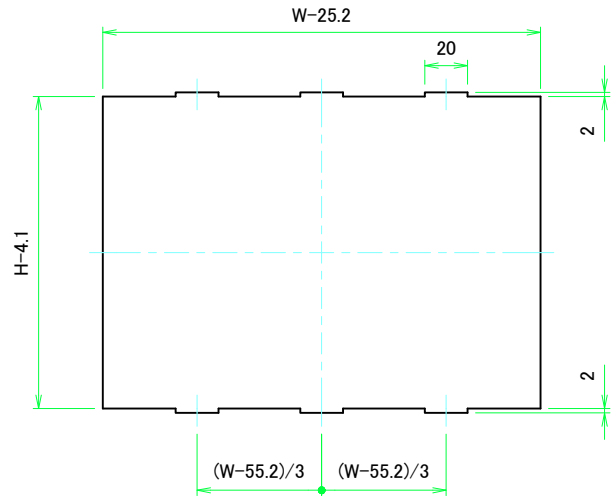

Wパネル1表面 / W Panel 1 Frontside

Wパネル1裏面 / W Panel 1 Backside

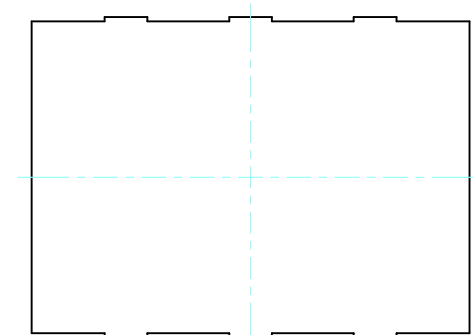
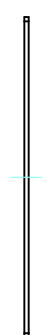
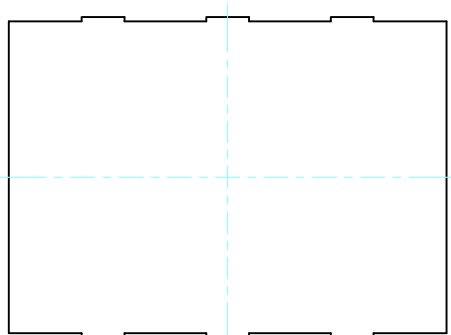

Wパネル2表面 / W Panel 2 Frontside

Wパネル2裏面 / W Panel 2 Backside

 株式会社タカチ電機工業 TAKACHI ELECTRONICS ENCLOSURE CO., LTD.			品名/Title 角型アルミフリーサイズケース CUSTOM SIZED ALUMINIUM CASE	 尺度/Scale 1:2.5
承認/Approved 中根	検図/Checked 常山	製図/Created 野村	型番/Product number ALSF□-□-□K20□ (W201~250, D151~200)	
			作成日/Date 2021/01/08	4 / 5

Dパネル / D Panel

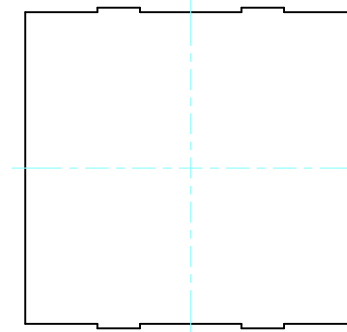
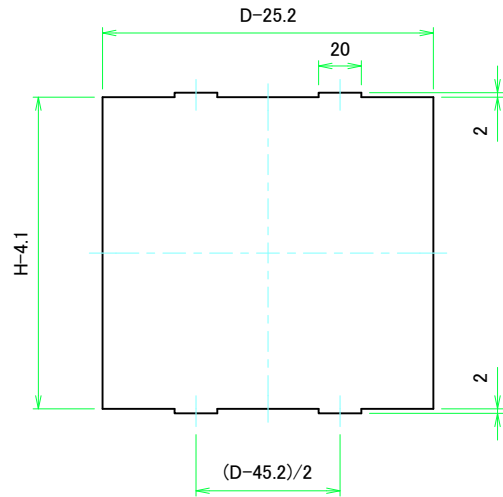

Dパネル1表面 / D Panel 1 Frontside

Dパネル1裏面 / D Panel 1 Backside

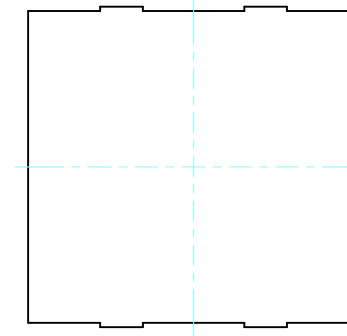
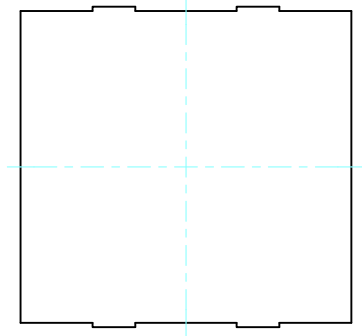

Dパネル2表面 / D Panel 2 Frontside

Dパネル2裏面 / D Panel 2 Backside

株式会社タカチ電機工業 <small>TAKACHI ELECTRONICS ENCLOSURE CO., LTD.</small>			品名/Title 角型アルミフリーサイズケース CUSTOM SIZED ALUMINIUM CASE	尺度/Scale 1:2.5
承認/Approved	検図/Checked	製図/Created	型番/Product number ALSF□-□-□K20□ (W201~250, D151~200)	
中根	常山	野村	作成日/Date 2021/01/08	5 / 5